

RODIX STANDARD INLINE INSTRUCTION BULLETIN

STANDARD INLINE, 5.125", ENGLISH
P/N 7-115, 120 VAC
P/N 7-117, 240 VAC

STANDARD INLINE, 12", ENGLISH
P/N 7-136, 120 VAC
P/N 7-143, 240 VAC

STANDARD INLINE, 7.75", ENGLISH
P/N 7-116, 120 VAC
P/N 7-118, 240 VAC

STANDARD INLINE, 14", ENGLISH
P/N 7-135, 120 VAC
P/N 7-144, 240 VAC

STANDARD INLINE, 10", ENGLISH
P/N 7-137, 120 VAC
P/N 7-142, 240 VAC

STANDARD INLINE, 7.75", METRIC COIL
P/N 7-152, 240 VAC

STANDARD INLINE, 10", METRIC COIL
P/N 7-151, 240 VAC

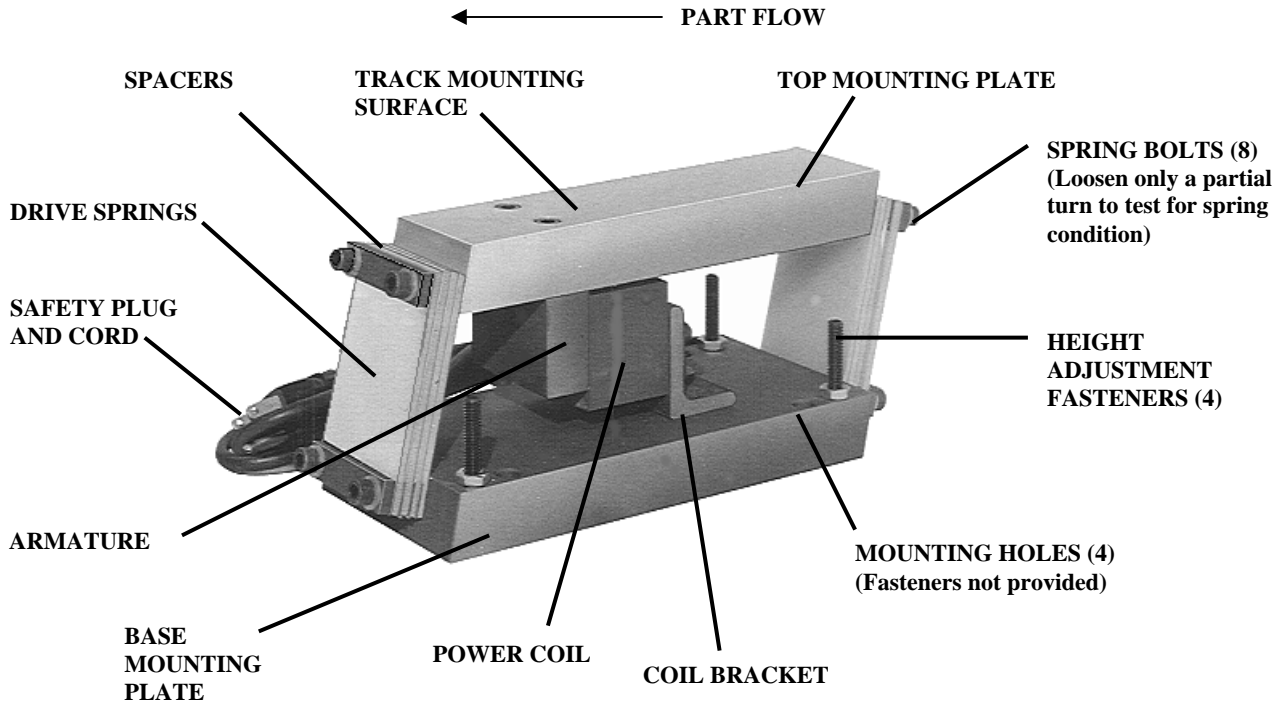

ADJUSTING THE VIBRATORY INLINE TRACK DRIVE TO ACHIEVE OPTIMUM FEED

STARTUP REQUIREMENTS

Before tuning a vibratory track inline drive, check for the following startup requirements:

1. The drive must be mounted on a solid steel surface so that it is anchored to a rigid mass that will not absorb the vibration. If a riser is needed, use solid steel, rather than tube steel or aluminum. The riser should not hang over the edge of the machine table.
2. For optimal performance stay within the track length and weight guideline listed on the drive drawing. There is a trade off between the track length and weight. Avoid designing a track that is the maximum weight and length listed. When the maximum length is used, the track must be much lighter than the maximum weight.
3. The track must be centered on the drive for the best efficiency.

There are several variable inputs that must be adjusted in the following order to achieve the optimum feed rate with your RODIX Vibratory Inline Track Drive.

1. The gap between the armature and power coil.
2. The number of drive springs.
3. The power setting of the vibration-amplitude dial on the vibratory feeder control.

NOTE: Changing the elevation of the height adjustment fasteners can affect the tuning.

ADJUSTING THE VIBRATORY INLINE TRACK DRIVE TO ACHIEVE OPTIMUM FEED

GAP SETTING

Loosen the bolt attaching the power coil bracket to the base mounting plate so the coil can be moved by hand. Use feeler gages to set the gap between the armature and power coil at .100 inch. The gap on both sides should be equal and the coil should be parallel to the armature. Never set the gap larger than .125 inch or less than .030 inch. During normal operation, don't allow the armature to hammer against the coil. In many applications, lighter tracks often use a wider gap, and heavier tracks may use a narrower gap. Tighten the bracket bolt so the power coil will not move when operating.

NOTE: The recommended setting for the power coil is 60 Pulses Per Second.

The parts will feed much faster at 60 pps than 120 pps. If the coil vibrates at 120 pps, the track drive is more difficult to tune and more springs are needed. The 120 pps rate is used only for special applications such as with parts that tend to "shingle" in a feed track.

NUMBER OF SPRINGS

The track should have a normal load of parts in place when testing to determine the correct number of drive springs required. The drive comes from the factory with more springs than is typically needed to achieve proper tuning. If tuning for 120 pps, start with two thin springs on the front and two on the back, and take off all of the thick springs.

If the parts do not move at all when the track drive control is turned ON, the drive is severely under-sprung. If the parts do nothing but bounce up and down when the control is turned ON, the drive is severely over-sprung. Loosening one of the spring bolts on the lower back side of the base mounting plate will have the equivalent effect of removing one spring. Determine the tuned condition by slowly loosening only one bolt just a partial-turn to break it free from its maximum torque and observing the results.

1. If the parts slow down suddenly, the drive is under-sprung. Correct this condition by adding one spring at a time to a spring bank or by substituting a thicker spring for one in place. Keep the number of springs per bank within one spring of each other. If both banks have the same number of springs, add one spring to the exit end of the track. Re-tighten the bolts and re-test the tuning every time a spring is added.

CAUTION: Be sure the spring bolts are long enough for any added thickness of springs. At least 5/16 inch of the bolt shank should be threaded into the bolt hole.

2. If the parts speed up suddenly, begin to bounce, or move backwards, the drive is over-sprung. Correct this condition by removing a spring or by substituting a thinner spring. Keep the number of springs per bank within one spring of each other, if both banks have the same number of springs, remove one spring from the entrance end of the track. Re-tighten the bolts and re-test the tuning every time a spring is removed.
3. If the parts speed up slightly at first and then slow down as the spring bolt is opened more, the track drive is operating correctly because it is slightly over-sprung.

When the Inline's control knob is set in the mid-range in the slightly over-sprung condition, the parts should move forward at the optimum feed rate. There should also be enough amplitude control left in the upper range for over-driving the parts. Then as the springs begin to age, there is enough of the control range remaining to turn up the control slightly and still maintain the optimum feed rate. If there is no movement of the parts in the feed track after continually removing springs until there are only two springs left on each end of the drive, close the coil gap down to .075 inch. If this fails, close the gap to .050 inch.

NOTE: The wider the gap, the more springs are required for proper operation.

PREVENTATIVE MAINTENANCE

The track tooling should be cleaned weekly. Denatured alcohol is typically used for this purpose.

Clean the coil air gap quarterly. Insert an appropriate thickness of shim stock into the gap to remove debris. Don't remove the coil or change the air gap setting during cleaning.

ADJUSTING THE VIBRATORY INLINE TRACK DRIVE TO ACHIEVE OPTIMUM FEED

POWER SETTING

For best results, the power setting on the inline's vibratory feeder control should be in the typical operating range (about 60% – 80%) when the drive is feeding parts at the optimum rate. For a Rodix FC-70 or FC-75 set the dial between 6-8. For other controls, connect a voltmeter to the output of the control while the inline is plugged in. Measure the voltage at full power. Then verify that the optimum rate is achieved within 60%-80% of the full power voltage.

After a few hours of operation at the maximum desired feed rate, monitor the coil temperature. It should be cool enough that you can hold your hand on it. If the coil temperature exceeds 140°F, reduce the coil gap or reduce the power setting of the feeder control.

PROBLEM SOLVING AND APPLICATION TIPS

Check for these problems if an inline drive is not operating properly:

1. For an intermittent or poor feed rate, check for loose fasteners. All fasteners must be properly tightened to the recommended torque:
10-32 or M5x0.8 SHCS 76 inch pounds or 8.5 newton meters
1/4"-20 SHCS 158 inch pounds or 17.8 newton meters
2. The track needs to be cleaned periodically. Use denatured alcohol to clean it.
3. The parts may be contaminated, magnetized, or have excessive burrs.
4. Gap between power coil and armature has changed, or the gap has foreign particles in it.
5. If a poor feed rate occurs, the spacers between springs may be missing or may have become misaligned.
6. The proper horizontal and vertical alignment of the springs, track, counter weight, and mounting feet must be maintained.
7. If the track drive only hums and it won't feed parts, check the inline's vibratory control. In most applications, the control should be set to 60 pulses per second, not 120.
8. If a poor feed rate occurs, make sure the track is mounted to a stiff and massive enough machine base or riser.
9. Avoid using the height adjustment fasteners if possible. When they are used, make sure that they are properly leveled and that the jam nuts are tight. Torque the 1/4"-20 screws to 16 foot pounds.
10. If several different inline track drives are mounted near each other, they may adversely vibrate each other. Minimize this by increasing the mass of the machine table, use separate machine tables, or change a setting on one of the Rodix feeder controls so that it operates on the opposite half of the sine wave. (Call Rodix for details).
11. If a dead spot on an inline track occurs, eliminate the problem by adding extra spacers between a spring bank and a mounting plate. If the slow spot is near the track exit, add spacers to the bottom of the spring bank that is by the exit. If the slow spot is by the track entrance, add spacers to the top of the spring bank that is located near the entrance.
12. For a long inline parts track that exceeds the normal capability of a track driver, use two or three track drives mounted in a long row on the same machine table. The rear drive should be a standard drive with a coil, the other drive(s) might not need a coil.

For Sales, Service, or Technical Assistance, please contact:

RODIX, INC.
2303 23rd Ave, Rockford, IL 61104
Toll Free (800) 562-1868
E-mail custserve@rodix.com
FAX (815) 316-4701
www.rodix.com

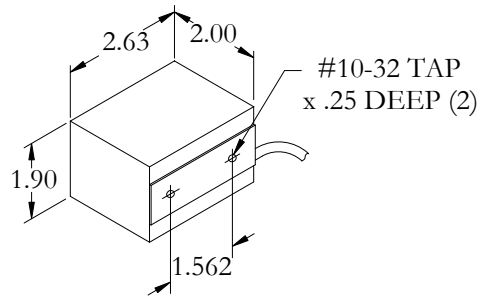

Standard Inline Coil
 120 VAC = P/N 6-42-075
 240 VAC = P/N 6-42-077

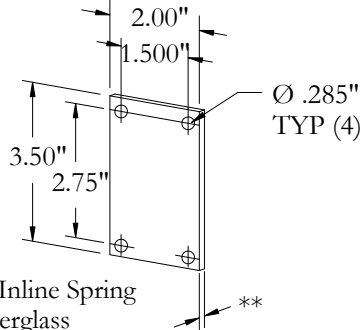

Standard Inline Spring
 Fiberglass
 **.094 Thk = P/N 90-1-03
 .125 Thk = P/N 90-1-04

- Coils:
 120 VAC: P/N 6-42-075
 240 VAC: P/N 6-42-077
 Springs:
 .094 Thk P/N 90-1-0003
 .125 Thk P/N 90-1-0004
 Spacer: P/N 88-3-0029

Drawing has no scale

Standard Inline 12" Long Models 7-136 (120 VAC) & 7-143 (240 VAC)

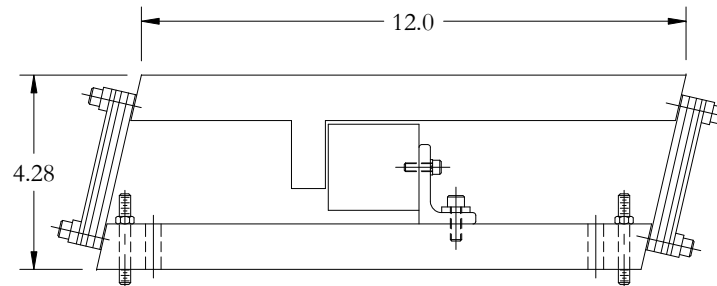
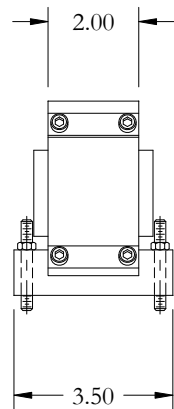
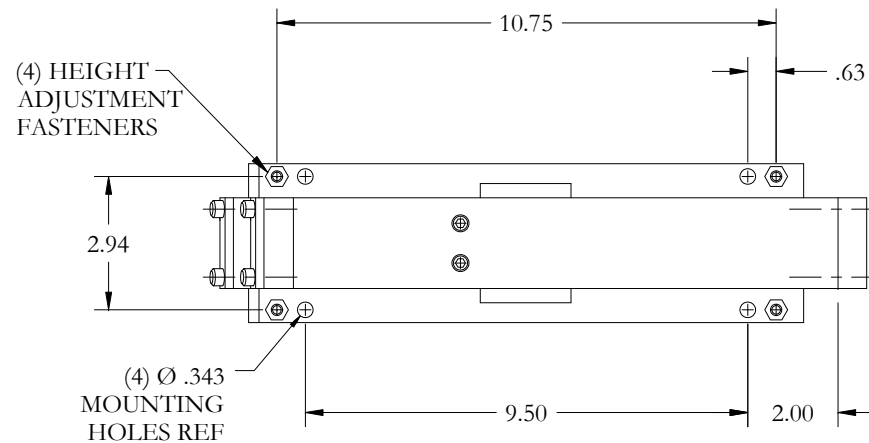

Models 7-136 & 7-143
 Track Length: 48" maximum
 Track weight limitations: 24 lbs maximum
 Electrical power: 7-136: 120 Volts, 50/60 Hz, .75 Amps
 7-143: 240 Volts, 50/60 Hz, .4 Amps
 Unit Weight: 18 lbs



Rodix, Inc. 2303 23rd Ave.
 Rockford, IL 61104
 Ph. (800) 562-1868 Fax (815) 316-4701
 www.rodix.com