



## Optional software features of the 24-490 / 24-491 circuit boards

**OVERVIEW:** The **FC-90 Plus Series** of feeder controls are built around the circuit boards P/N 24-490 (120VAC) and 24-491 (230VAC). This section covers the optional program features. Positions SW6 through SW10 of the 10 position DIP Switch (S1) can be set to enable alternate program features. The program features should be chosen based on the customer application.

**PROGRAMMING:** By selecting the correct switch combinations of SW6 through SW10, it is possible to run a desired program feature instead of the "standard program."

*Caution: If more than one software function is desired, please check Table 1 to find the exact programming selections needed; otherwise, the board may run a software program that does not fit the application.*

**1. 60 Pulse Polarity Reversal:** Normally in the 60 Pulse (half-wave rectified) mode, the output voltage is turned on only during the bottom half of the sine wave. However with the 60 Pulse Polarity Reversal software feature, the top half of the sine wave is used instead of the bottom half.

Use this feature to reduce mechanical interaction between two vibratory feeders. Mechanical interaction can occur when both feeders use the 60 Pulse mode and they share the same machine base. Mechanical interaction can cause the vibration from one feeder to effect the other feeder. A typical symptom of this is when turning one feeder's vibration up causes the vibration to increase or decrease on the other feeder. To solve this problem, more mass can be added to the machine base, or use the Polarity Reversal feature. This feature alters the timing on one feeder so that each feeder is pushing against the machine base at a different time.

A second reason for reversing the polarity of the 60 pulse waveform is to reduce the apparent power when two or more feeders are connected to the same branch of an electrical power distribution circuit. An example is a vibratory feeder system where each unit is set to 60 pulse mode. If there is a hopper feeding at 1.5 Amps, a bowl feeding at 5 Amps, and an inline feeding at 1 Amp, then the measured current of the branch would be 7.5 Amps. But if the 60 pulse waveform were reversed on the bowl, then the apparent current of the branch would be reduced some because the current flows in both directions instead of only one. This would cause the branch step down transformer to operate a little cooler and the measured wattage at the utility meter to decrease. See the "Waveform Reversal" in the "S1 Programming Chart" for programming details.

S1 Programming Chart					
Program Description	S1 Switch Positions				
	SW 6	SW 7	SW 8	SW 9	SW 10
0 = Off 1 = On					
Standard Program	0	0	0	0	0
Constant ON	0	0	0	0	1
High/Low Track	0	0	0	1	0
Linear Pot Taper	0	0	0	1	1
0-20mA	0	0	1	0	0
2-Speed Operation	0	0	1	0	1
Bowl Out Parts, Stop	0	0	1	1	0
BOP stop/ with alarm	0	0	1	1	1
BOP alarm w/o stop	0	1	0	0	0
30/15 hertz operation	0	1	0	0	1
Aux Invert	0	1	0	1	0
Air Jet Timers	0	1	0	1	1
40 Pulse operation	0	1	1	0	0
Option Program	0	1	1	0	1
Optional Program	0	1	1	1	0
Optional Program	0	1	1	1	1
Waveform Reversal	1	0	0	0	0
Constant ON, WR	1	0	0	0	1
High/Low Track, WR	1	0	0	1	0
Linear Pot Taper, WR	1	0	0	1	1
0-20mA, WR	1	0	1	0	0
Optional Program	1	0	1	0	1
Optional Program	1	0	1	1	0
Optional Program	1	0	1	1	1

**2. High and Low Track Sensors:** This option maintains the parts level between a high-level sensor and a low-level sensor on the track. One purpose for this is to keep a consistent reservoir of parts on the track so the machine process does not run out of parts without causing too much back pressure. This feature also can be used to make a feeder bowl run more efficiently because it only turns ON when parts are needed, and it only turns OFF when the track is full of parts. Better efficiency reduces the amount of wear on the tooling of the feeder bowl.

When the parts level drops below the low-level parts sensor, the feeder turns ON after any time delay. The feeder runs until the parts reach the high-level shut off sensor and the timer times out. The feeder stays off until the low-level is reached again. See the "Switch Programming Chart" for programming details.

Two PNP parts sensors are required. The first sensor connects as normal to the Sensor input. It does not matter whether the high or low level sensor is connected to the Sensor input or the Run input. The wiring for Sensor input is as follows: TB2-4 is ground. TB2-5 is the Signal. TB2-6 is +12VDC. The second parts sensor connects to the Run input. The wiring for the Run input is as follows: TB2-7 is ground. TB2-8 is the Signal. TB2-9 is +12VDC.

**3. Two-Speed Pot Operation:** Some vibratory feeder applications need to operate at two different speeds. For example: Nail feeders operate on low speed while starting up the machine, and then switch to high speed for normal operation. Packaging machines operate at high speed while filling the package. When the package is nearly full, it switches to low speed to accurately finish filling it.

For the two-speed operation, the Main Pot sets the high speed, and the MIN trimpot sets the low speed. The part sensor is used to switch between the two speeds. Opening the Run jumper stops operation.

**4. The “Constant On” feature** can be used to keep the bowl running continually while the Aux output switches power to a device (air valve) to blow the unneeded parts back into the bowl. The parts sensor and delay timers determine the state of the Aux output.

**5. Bowl Out of Parts Timer or Jam Detect Timer:**

When no parts pass before the parts sensor, it can be concluded that either the feeder has run out of parts or has experienced a parts jam. To prevent problems, it may be desirable to inhibit bowl feeding by turning the feeder output off until the problem gets resolved. This can save power, prevent needless non-productive wear and it can signal personnel (See “Bowl Out of Parts or Jam Detect Timer with Alarm”). Restart the feeding process by passing a part in front of the parts sensor, or cycle the RUN input, or turn the Power switch OFF and then back ON again.

The Minimum trimpot serves as the timer for detecting when a part has not passed in front of the parts sensor. The timer has an adjustable range of 5 to 120 (CW) seconds.

**6. Bowl Out of Parts with Alarm or Jam Detect Timer with Alarm:** The auxiliary output can be set so that the alarm signal can indicate when the bowl out-of-parts timer has stopped bowl feeding. See the “Bowl Out of Parts or Jam Detect Timer” for feature description. Note: the bowl/hopper interlock feature will not work when the “Bowl Out of Parts or Jam Detect Timer with Alarm” is selected.

**7. Bowl Out of Parts Alarm without Stop or Jam Detect Timer without Stop:** The auxiliary output can be set so that the alarm signal can indicate when the bowl out-of-parts timer has occurred while the bowl continues feeding. Note: the bowl/hopper interlock feature will not work when this feature is selected.

**8. Aux Output Signal Invert:** The auxiliary output can be set to have its signal inverted from the output of the feeder.

**9. Air Jet Sequence:** The auxiliary output can be set to activate an air solenoid 1 second before feeding begins and remain on until 4 seconds after feeding ends. This feature is helpful for parts orientation.

**10. The “0-20mA” feature** increases the range of the 4-20mA input. The range increase can make it easier to fine tune the feed rate by providing more resolution per milliamp.

**11. Low Pulse Rate:** Some feeder manufactures may choose to spring their feeder for a low pulse rate when they determine that is the best way to handle the part. Low pulse rate is not intended to work on vibratory feeders tuned for 60 or 120 pulse.

The Low Pulse Rate modes can be combined with the Constant Feed Rate (CFR) feature.

**Low Pulse Rate - Single Pulse: 40 PPS (Pulse-Per-Second) Output:** With 60 Hz input power, this option allows the control to produce frequency of 40, PPS. (For 50 Hz input power, the frequency is 33.3 PPS). The Single Pulse mode provides one pulse of power followed by an OFF period in order to produce the desired frequencies. To determine the pulses per minute, multiply the PPS by 60. Example:  $40\text{PPS} \times 60 = 2400$  Pulses per minute.

**Low Pulse Rate - Pulse Train: 30 and 15 PPS (Pulse-Per-Second) Output:** With 60 Hz input power, this option allows the control to produce frequencies of 30 and 15 PPS. (For 50 Hz input power, the frequencies are 25 and 12.5 PPS). This Pulse Train mode sends a series of ON pulses followed by an OFF period is used to produce the frequencies. Set the 60/120 switch to “120” for “30” pulse and to “60” for “15” pulse while the 30 pulse feature is selected.

Vibratory feeders with large parts, large tray feeders and a few inline track applications may be operated below 60 PPS. A vibratory feeder that is converted to a lower pulse mode will require fewer springs.



**RODIX INC.**  
**FEEDER CUBE®**  
**FC-90 Plus Series**  
**ADVANCED FEATURES**

## Optional Wiring Configurations for the **24-490 / 24-491 circuit boards**

### OVERVIEW

The **FC-90 Plus Series** of feeder controls is built around circuit boards 24-490 (120VAC) and 24-491 (230VAC). The input voltage tolerance for the 24-490 board is 90-120VAC ( or 115V +/- 10%). The input voltage tolerance for the 24-491 board is 180-240VAC (or 230V +/- 10%). Note: vibratory feeders may not feed well at low line conditions. Each board contains two power supplies, phase-angle firing control for the triac, a Sensor input, a "Run" input, one or two speed inputs, one auxiliary output, and logic circuitry to perform on-delays and off-delays.

### POWER SUPPLY

The 12VDC power supply is available for external use having a maximum current capacity of 100mA. The power supply can be isolated from TB2 by removing the 0 Ohm SMT resistors illustrated in the FC-90 Plus Interface Diagram.

### 0-5VDC & 4-20mA ANALOG INPUTS

The **FC-90 Plus Series** feeder control has a **0-5VDC** analog signal input and a **4-20mA** analog signal input for controlling the vibration level of the feeder bowl.

**0-5VDC input:** Either a potentiometer or a 0-5VDC input signal can be used to control the output level of the control.

A potentiometer (Main control pot) normally is connected to the analog input of H1 to vary the output level of the control. This pot acts as a voltage divider across the 5VDC power supply providing a 0-5VDC signal.

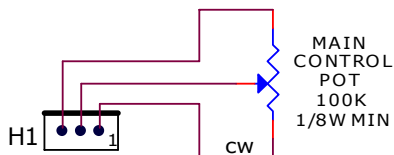

Remote pot operation can be achieved by using a 3-wire shielded cable connected to H1, the analog input. The shield (drain wire) should be connected to the chassis ground only at the Rodix control end of the cable. See the wiring diagram for pot wiring connections.

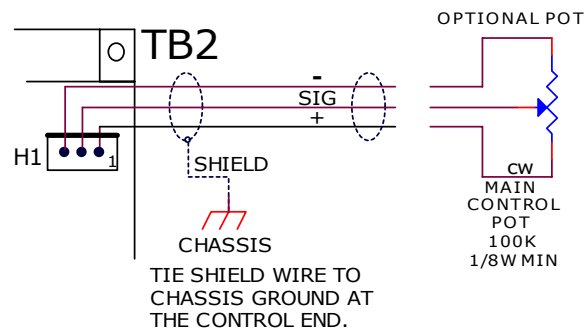

A 0-5VDC signal can be applied to H1, the analog input instead of using the Main pot. The 0-5VDC analog input signal may be applied between terminals 2 and 3 of header H1. Connect the ground to terminal 3 and the signal to terminal 2. To improve noise immunity, remove the wire from pin 1 of connector H1.

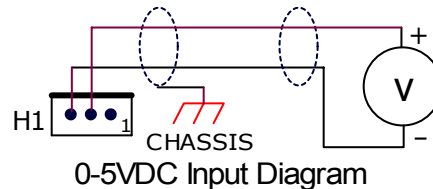

A 0-10VDC signal can be applied to the analog input by using a voltage divider circuit to scale the input voltage to 0-5VDC. See figure below.

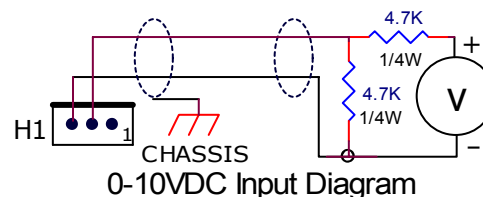

The H1 cable is provided with the **FC-94 Plus** control. The cable, P/N 123-145 may be used anytime a remote signal or a remote pot is used. The shield of the "H1" cable should be tied to chassis ground at the Rodix end of the cable.

**4-20mA input:** a **4-20mA signal** is the second type of input signal that can control the output vibration level. This method has a better signal to noise ratio than the 0-5VDC input control. Connect the 4-20mA signal to TB2-11 (GND) and TB2-12 (SIG) to allow the bowl's vibration level to be adjusted remotely.

The Main control pot is automatically disabled whenever the 4-20mA input current is above 4mA. When the 4-20mA input current is at 0mA, control of the vibration level goes back to the H1 Main pot input.

### Application Hints:

For Local/Remote control of the vibration level, use a switch to toggle between the 4-20mA input and the control pot. The switch interrupts the 4-20mA current at TB2-12.

To use only the 4-20mA input to control the vibration level, disconnect the pot cable connected to H1.

When an analog input signal is used, the analog input signal should be applied after line power has been applied to the control.

The control produces a special logarithmic-tapered power output curve from the information given by the Main pot or 4-20mA input. The special taper spreads the power curve broadly across the pot range, helping to give maximum fine control over the control's output. For extra fine pot control, five and ten-turn pot kits are available from RODIX.

## RUN INPUT

Remote OFF/ON control normally can be accomplished by using a dry relay contact at terminals TB2-8 and TB2-9. When a contact is unavailable, one of the following can be used.

A PLC having an NPN (current sinking) output can provide remote OFF/ON control to the control's Run input. Connect the PLC's NPN output to TB2-7 (-). Connect the PLC's power supply (5-30VDC) to TB2-8 (Pos). Apply the signal whenever the control should be enabled. Electrical isolation of the Run Input is optional. Remove resistor R3 from the FC-90 *Plus* circuit board when isolation is desirable. Use pliers to twist and snap off resistor.

A PLC having a PNP (current sourcing) output can provide remote OFF/ON control to the control's Run input. Connect the PLC's PNP output (5-30VDC) to TB2-8 (SIG). Connect the PLC's ground to TB2-7 (Gnd). Apply the signal whenever the control should be enabled. Electrical isolation of the Run Input is optional. Remove resistor R3 near TB2 from the FC-90 *Plus* circuit board when isolation is desirable. Use pliers to twist and snap off resistor.

## AUXILIARY OUTPUT

The auxiliary output is useful for controlling other feeder controls, solid-state relays, small DC air valves, and PLC inputs. The auxiliary (interlock) output turns ON whenever the control output is ON.

The AUX output comes from the factory configured to sink current from the internal power supply: see the "typical relay or air valve wiring" drawing. The AUX output can be configured to sink or source current from the internal power supply which is rated at 100mA or from an external power supply.

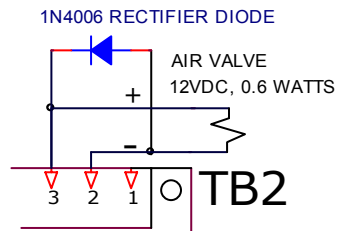

Typical relay or air valve wiring

The AUX output can be reconfigured to source current by removing resistor R4. Next connect the voltage supply to TB2-2. TB2-1 becomes the sourcing output to the load. Be sure to connect the other terminal of the load to the sourcing power supply's ground.

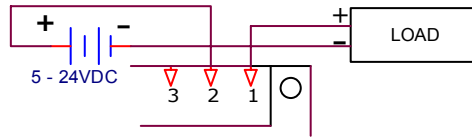

CONFIGURED FOR SOURCING CURRENT

The AUX output is capable of switching 80mA at 24VDC when an external power supply is used. To isolate the internal power supply from an external power supply connected to the Aux output, resistor R4 must be removed from the circuit board. Use pliers to twist and snap off resistors.

Inductive loads or loads with a relay coil connected to the auxiliary output produce a negative voltage spike when the coil is de-energized. In order to protect the on board semi-conductors from a negative voltage, connect a reverse biased diode across the inductive load. A rectifier diode can be connected across the coil by connecting the side of the diode with a band to the positive side of the coil, and connect the side without the band to the negative side of the coil. A 1N4006 diode, P/N 115-31 is available from Rodix.

## ISOLATION

The FC-90 *Plus Series* control is transformer isolated from the line, the isolation is rated at 2500V. The chassis to ground isolation is 1000V. The sensor input, run input, analog (pot) input and interlock output all share the same power supply common. The sensor input can be optically isolated if parts R1 and R2 are removed from the circuit board. The sensor power must then be supplied from an external 5-30VDC source. The run input and interlock output are optically isolated only when parts R3 and R4 are removed, please read all directions before removing them. Use pliers to twist and snap off resistors.

## NOISE IMMUNITY

For further details about noise immunity, see the **Feeder Cube®** application note for your model and the Rodix Solution titled Good Wiring Practices for Avoiding Electrical Noise Problems. For high field environments where the wire length is over 2 meters, it is recommended that shielded wires be used for the signal wires. Ground the drain wire at the control end.

## Technical Support

Application notes, troubleshooting guides, and Rodix solution guides are available at [www.rodix.com](http://www.rodix.com).

## **RODIX, INC.**

2303 23<sup>rd</sup> Avenue, Rockford, IL 61104

Toll Free (800) 562-1868

E-mail [custserve@rodix.com](mailto:custserve@rodix.com)

FAX (815) 316-4701

[www.rodix.com](http://www.rodix.com)

CFR "-"

CFR "+"

AUX OUTPUT USED TO INTERLOCK ANOTHER CONTROLLER OR TO DRIVE AUXILLARY EQUIP. TO SOURCE CURRENT USE: 3 (+) & 2 (SIG) TO SINK CURRENT USE: 2 (SIG) & 1 (COM)

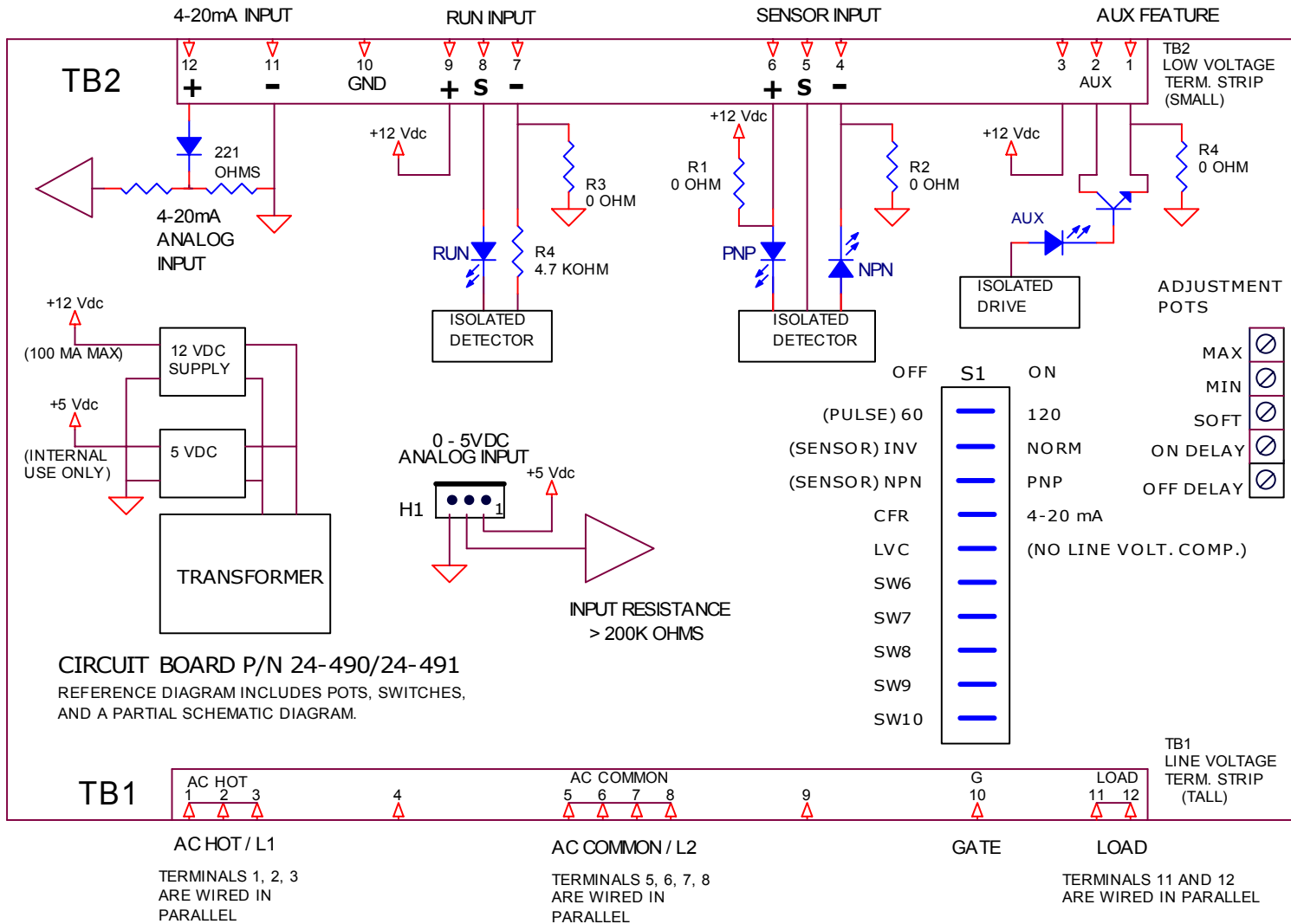

# FC-90 PLUS INTERFACE DIAGRAM

FC-90 PLUS SERIES EQUIVALENT CIRCUIT  
COPYRIGHT 1997, 2008 RODIX INC.

ATTENTION: SENSOR AND/OR FIELD CONNECTIONS HAVE CHANGED FROM PREVIOUS MODELS.  
THIS DIAGRAM IS FOR REFERENCE ONLY, SEE FC-90 PLUS SERIES  
APPLICATION NOTE FOR INTERCONNECT WIRING.

**RODIX, INC.**  
2303 23<sup>rd</sup> Avenue, Rockford, IL 61104  
Toll Free (800) 562-1868  
Email: [custserve@rodix.com](mailto:custserve@rodix.com)  
FAX (815) 316-4701  
[www.rodix.com](http://www.rodix.com)